

# Discover the New Possibilities of Automated Petrography



## **ZEISS Axioscan 7**

Your Unique Automated Petrographic Microscope for Digitization, Quantification and Collaboration

[www.zeiss.com/axioscan-geo](http://www.zeiss.com/axioscan-geo)



Seeing beyond

# A Revolutionary Technology for Polarization Microscopy

- › In Brief
- › The Advantages
- › The Applications
- › The System
- › Technology and Details
- › Service

Digitize your thin sections with ZEISS Axioscan 7 – the reliable, reproducible way to create high quality, digitized petrography data in transmitted and reflected light. Uniquely designed for petrographic analysis, the Axioscan 7 combines motorized polarization acquisition modes with unprecedented speed and a rich software ecosystem for visualization, analysis and collaboration. Fully automated acquisition is coupled with ZEISS quality to ensure consistently high image quality, even when processing hundreds or thousands of samples. Motorized plane and cross polarization allows for both pleochroism and birefringence to be analyzed, whilst circular polarization allows for the rapid assessment of characteristic maximum birefringence regardless of grain orientation.

In the ZEN software ecosystem data can be seamlessly integrated into complex digital analysis workflows. The ZEN polarization viewer allows for complex multi-channel polarization data to be visualized and interrogated in a user friendly and intuitive environment. ZEN Intellesis allows for powerful machine-learning based phase identification, and ZEN Image Analysis allows for highly optimized measurements to be made on classified images, resulting in quantitative measurements of mineralogy, grain size and mineral distributions. Data can then be automatically uploaded to the cloud for online visualization, distribution and collaboration using ZEN Data Storage. Share your images online with colleagues and organize entire projects, even when you are on the go.

For the first time, automated polarization microscopy is compatible with imaging modalities commonly used in the biosciences, making the ZEISS Axioscan 7 the only choice for central facilities, serving the diverse requirements of multiple departments.

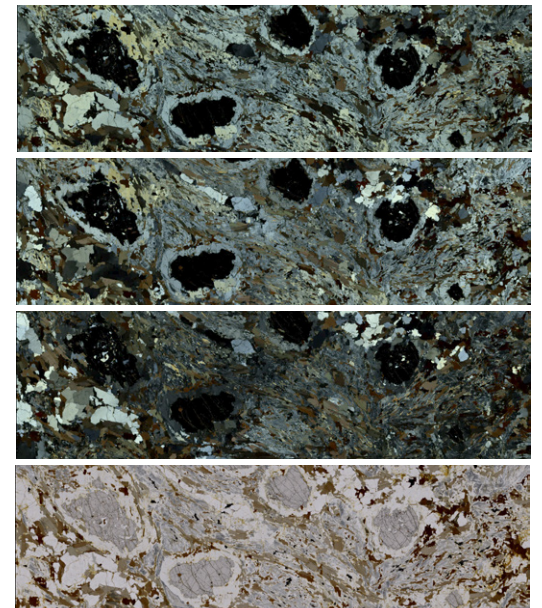

Automated, rapid acquisition of multiple modes for virtual petrographic microscope in multiple orientations for PPL and XPL



# Accelerated. Automated. Correlated.

- › In Brief
- › **The Advantages**
- › The Applications
- › The System
- › Technology and Details
- › Service

## Digitize complete petrographic information from massive sample collections at unprecedented speed

Digitize geological samples in multiple image modalities using optimized high speed multichannel acquisition to generate a data rich description of your sample. A motorized polarizer and an analyzer turret create a virtual rotatable stage with respect to a fixed sample. This allows assessment of characteristic pleochroism and birefringence in plane and cross polarized light respectively. Circular polarization is also available, showing maximum possible birefringence in a sample for mineral identification and image analysis needs.

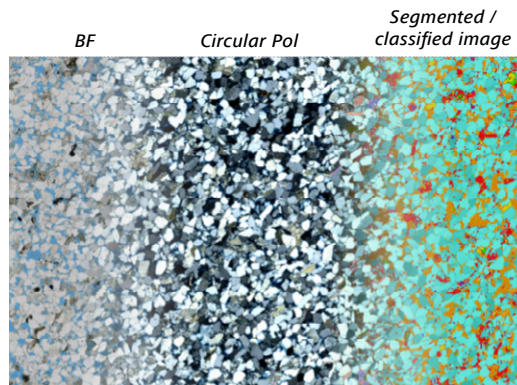

Composite multichannel acquisition of Berea Sandstone, showing Brightfield acquisition (left), circular polarized (maximum birefringence) acquisition (center) and the result of phase segmentation analysis (right). Machine learning segmentation is used to classify pore (gold), quartz (light blue), Calcite (dark blue), Micas (red) and opaque minerals (green and yellow).

## Collaborate without borders with a virtual petrographic microscope

Upload acquired data to cloud platforms, allowing for global image storage and transfer alongside intuitive collaboration. Digitize entire collections to allow for online and remote teaching. Integrate this data into existing courses to enable virtual field-trips, supporting and augmenting traditional modes of learning.

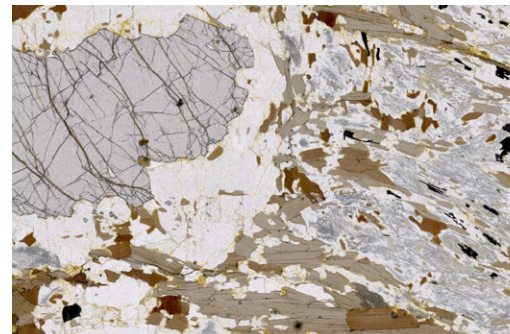

This browser based environment is ideal for data sharing and online learning. Allowing cataloging and viewing of digitised thin sections in multiple polarization orientations

## Revolutionize quantitative petrography with machine learning on large datasets

Multichannel data from the ZEISS Axioscan 7 are ideally suited for advanced digital analysis. Utilize the ZEISS integrated toolbox, including ZEN Intellesis and Image Analysis, allowing for modal mineral abundances, grain sizes and phase and texture distributions to be assessed. Expand this capability using the Solutions Lab, allowing for advanced or bespoke analysis, including automated grain identification and streamlined report generation. By feeding into the ZEN imaging ecosystem, the Axioscan 7 forms a natural start to correlative workflows, combining petrographic observations with electron and X-ray microscopy data.

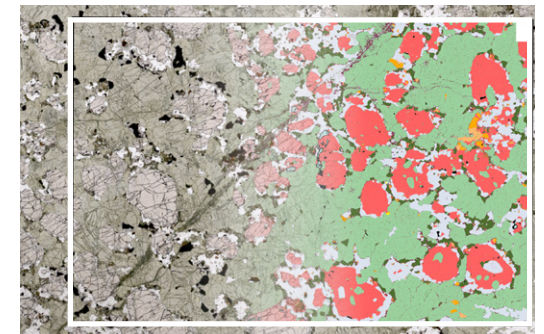

Digitisation of light microscopy information allows the design of correlative projects right from the first petrographic observations. Geochemical information is seen here seamlessly overlaid on Axioscan 7 imagery for a metagabbro from north west Scotland

# Unique Technology for Polarization Microscopy

- › In Brief
- › **The Advantages**
- › The Applications
- › The System
- › Technology and Details
- › Service

## Polarization images with unprecedented flexibility

Use a combination of motorized polarization components to acquire a range of plane polarized, cross linear polarized, circular polarized, brightfield and fluorescence channels. A full petrographic dataset may consist of more than 14 channels, and the Axioscan 7 automatically acquires these channels rapidly and efficiently, combining the precise motorized stage with a new image acquisition system. Aperture settings are automatically adjusted and optimized to the numerical aperture of the selected objective. Data acquisition and processing occurs in parallel to allow for optimized datasets of a manageable size ready for analysis, transfer or distribution just as data acquisition finishes. Polarization microscopy can be further augmented with fluorescence illumination to provide unparalleled levels of information about your sample. This capability also allows for life science and earth science applications to be examined on the same system for core facilities.



*The Axioscan 7 brightfield imaging performance is driven by a motorized condenser and a powerful white light source:*

- 1) Motorized modulator disc
- 2) Circular polarizer
- 3) Motorized linear polarizer
- 4) Motorized aperture diaphragm
- 5) White light LED light source

## The Modular Tray Concept: Flexible slide sizes for all geoscience tasks

Decide how many slides, what detection modes and what camera you want to use at the outset, then retrofit your Axioscan 7 as required: as your tasks grow, it grows alongside them. The tray design affords you maximum freedom with very broad tolerances for the slides, giving you the capacity for digitizing specimen slides of 26 mm × 77 mm, 52 mm × 77 mm, 106 mm × 77 mm and 28 × 48 mm standard petrographic thin sections

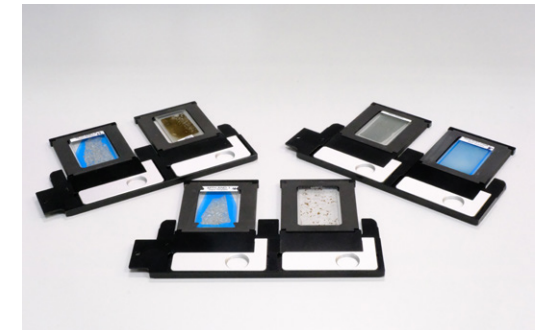



# Your Insight into the Technology Behind It

- › In Brief
- › **The Advantages**
- › The Applications
- › The System
- › Technology and Details
- › Service

## **The high power transmitted light LED allows for extremely rapid digitization, even in polarization microscopy**

The new high power vis-LED is 4X more powerful than previous illumination systems, allowing for high-speed continuous data acquisition even in polarization illumination modes. This allows for acquisitions orders of magnitudes faster than traditional systems, making the digitization of entire libraries and collections with hundreds or thousands of samples practical for the first time; even in demanding petrographic acquisition modes. This allows for multi-polarized data to be acquired with seven channels at around 6 mins per cm<sup>2</sup>. The ability to load up to 50 sections at a time allows for digitization to occur 24/7, maximizing sample throughput and data availability. Data acquisition is synchronized with a sequence of advanced and fast image processing steps, ensuring that data channels are always perfectly aligned, so they are prepared for subsequent machine-learning based analysis. High-performance scalable data compression is integrated as well, keeping data volumes down to manageable levels, and as all processing is performed in parallel with acquisition, analysis-ready data can be automatically streamed to server storage locations or uploaded to the cloud.



## **Flexible ZEISS camera options**

ZEISS Axioscan 7 is equipped with the latest state-of-the-art ZEISS cameras for brightfield, polarization and fluorescence applications. The AxioCam 705 color improves the speed, pixel density and field of view of Axioscan 7, and is the camera of choice for brightfield, polarization and even standard fluorescence applications.

The AxioCam 712 mono is the camera of choice for fluorescence applications with sensitive samples keeping phototoxicity in check. With low noise and a small pixel size, it achieves high quality images even with gentle sample illumination.

# Expand Your Possibilities

- › In Brief
- › **The Advantages**
- › The Applications
- › The System
- › Technology and Details
- › Service

## ZEN Pol Viewer display – the digital petrographic microscope: Visualize complex digitized petrographic data

Managing the multiple channels that constitute large scale petrographic thin section scans requires specialized visualization solutions. Use the new ZEN Pol Viewer display to navigate these rich datasets intuitively in a way that goes beyond the standard petrographic microscope. Available with every full ZEN version, it enables you to select which contrast to display (brightfield, plane polarization, cross polarization, circular polarization and fluorescence) and allows a synchronized movement through the available polarization angles. It will even automatically synchronize image rotation such that the sample appears exactly as it would in a traditional petrographic light microscope, facilitating the learning process in a teaching environment in the lab and online, creating an immersive petrographic experience.

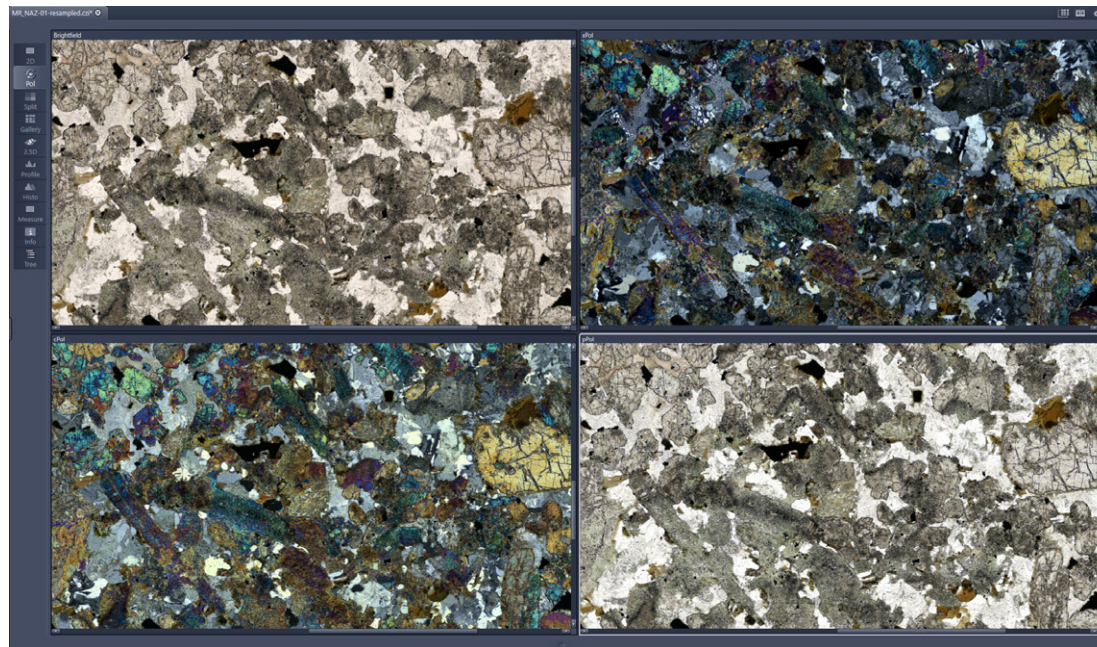

Unique ZEN Pol Viewer allows multiple image modalities to be viewed side by side. This includes simultaneous rotation of the sample in PPL and XPL, giving an exceptional virtual petrographic microscope experience.

## ZEN Data Storage and Explorer: Vast amounts of data at your fingertips, anytime, anyplace

Geological teaching and research require global collaboration. Remote access to teaching collections augments traditional teaching approaches through blended learning, allowing for the easier and more complete assimilation of complex ideas. For distributed research groups or asset teams, the ability to interact with data through a digital interface is crucial to always allow for the seamless distribution of and access to data. Download data directly from this online portal to enjoy the rich features available with ZEN lite or with the ZEN Pol Viewer display available in any licensed version of ZEN (version 3.4 or later). Access an example thin section repository here: [rmi-datastorage.westus.cloudapp.azure.com](http://rmi-datastorage.westus.cloudapp.azure.com)

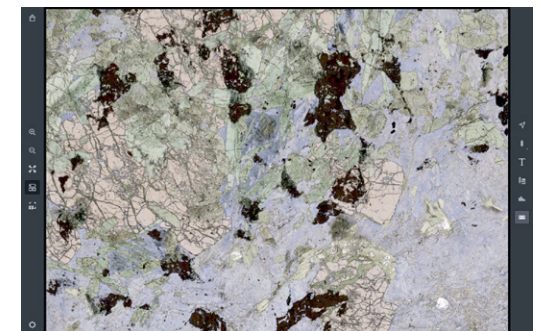

Garnet-bearing bluechist viewed through the ZEN Data Explorer online portal. Smart server solutions allow collaboration and correlative project building with ease.



# Expand Your Possibilities

- › In Brief
- › **The Advantages**
- › The Applications
- › The System
- › Technology and Details
- › Service

## Automate mineral classification and analysis ZEN Intellesis and Image Analysis

Traditional methods for extracting quantitative information from light microscopy datasets (i.e. point counting) are extremely time consuming and limit the extractable data to simple modal mineralogy and qualitative analysis of texture. State-of-the-art machine learning techniques available in ZEN Intellesis allow for mineral classification directly from the light microscope image. Trained models can be integrated into automated image analysis routines, allowing for automated mineral, pore and grain size measurement and reporting.

Models, once trained, can be applied on multiple samples of a similar type or batch. This allows for the quantitative assessment of the changes in distribution of sample mineralogy and texture e.g. through a series, of an extended section of core or field traverse.

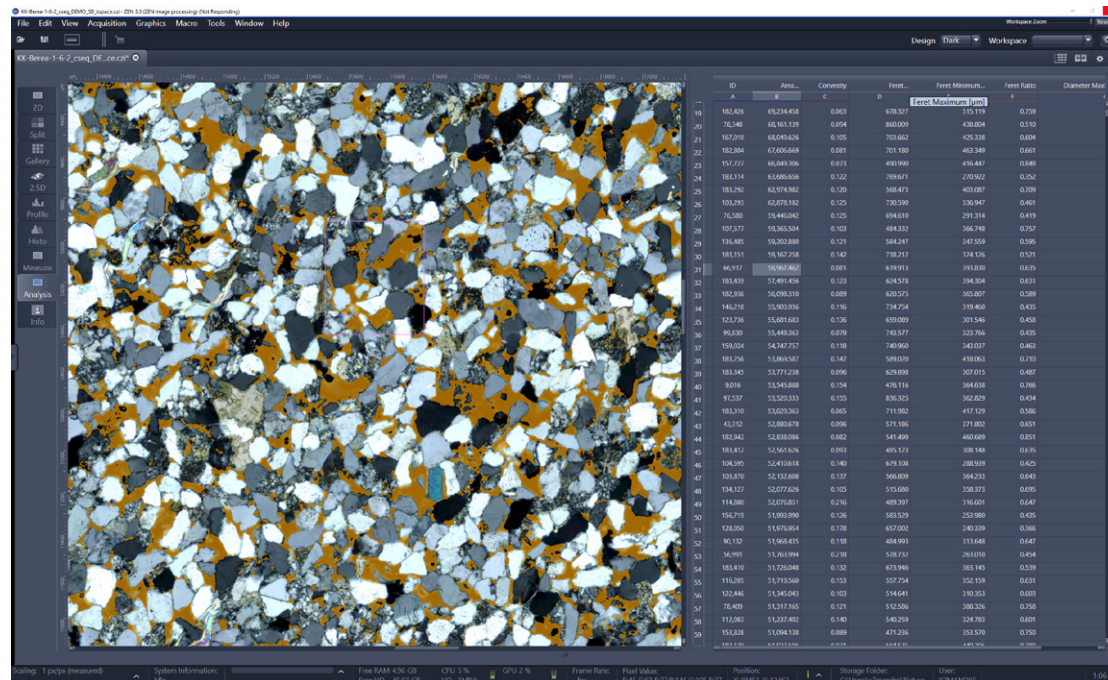

Pore and mineral classification and analysis of Berea sandstone, allowing for automated measurement and quantification.

## Build correlative microscopy projects with quantitative geochemistry and mineralogy

Light microscopy is often just the first part of petrological studies, providing broad scale contextualization for detailed techniques such as scanning electron microscopy, automated mineralogy, electron microprobe analysis and other microanalytical techniques. These analyses can be targeted using macro-scale contextual characterization using large area digitized light microscopy. Sample centric SEM workflows can be driven directly on light microscopy data using the Atlas 5 software. Automated quantitative mineralogy workflows can be performed using ZEISS Mineralogic software and all data can be integrated together and correlated using ZEN Connect.

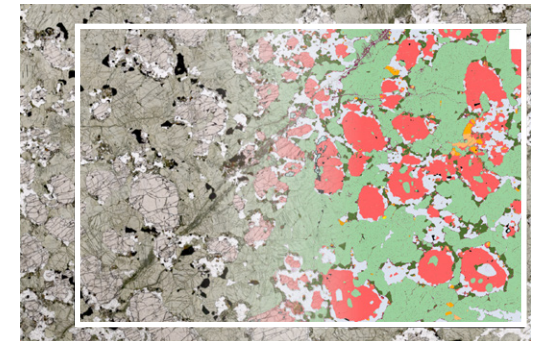

ZEN Connect can be used to intuitively build correlative projects that start with the data-rich, light microscopy environment from ZEISS AxioScan 7. Here additional phase and geochemical information from ZEISS Mineralogic becomes the next step in a petrological investigation. Sample shown is a granulite facies metagabbro from Scouriemore, North West Scotland.

# Expand Your Possibilities

- › In Brief
- › **The Advantages**
- › The Applications
- › The System
- › Technology and Details
- › Service

## **Core Imaging Facilities: A sound investment that quickly pays for itself**

In core imaging facilities, the demand for higher throughput and screening capability drives the charge towards automated instruments. Automation is convenient, but some platforms suffer from compromises in flexibility or image quality which will significantly impact the number of users wanting to make use of it. ZEISS Axioscan 7 provides automation without sacrificing flexibility or the high quality of images you need to attract a very wide range of users to your facility. With approaches as varied as fluorescence multiplexing in tissue sections to polarization in rock sections, there is a great opportunity to attract users from departments as diverse as Life Sciences, Earth Sciences and service labs, addressing the needs of a broad array of different user types. As well as offering flexibility, Axioscan 7 is designed for 24/7 usage. This powerful combination of accommodating a broad user base with robust design places Axioscan 7 as a top performer when it comes to usage hours and it quickly pays for itself. Axioscan 7 complements the other instruments in your facility and conveniently integrates into time saving workflows. Automatic, high quality screening of hundreds of samples for identification of regions or events of interest is fast and efficient.

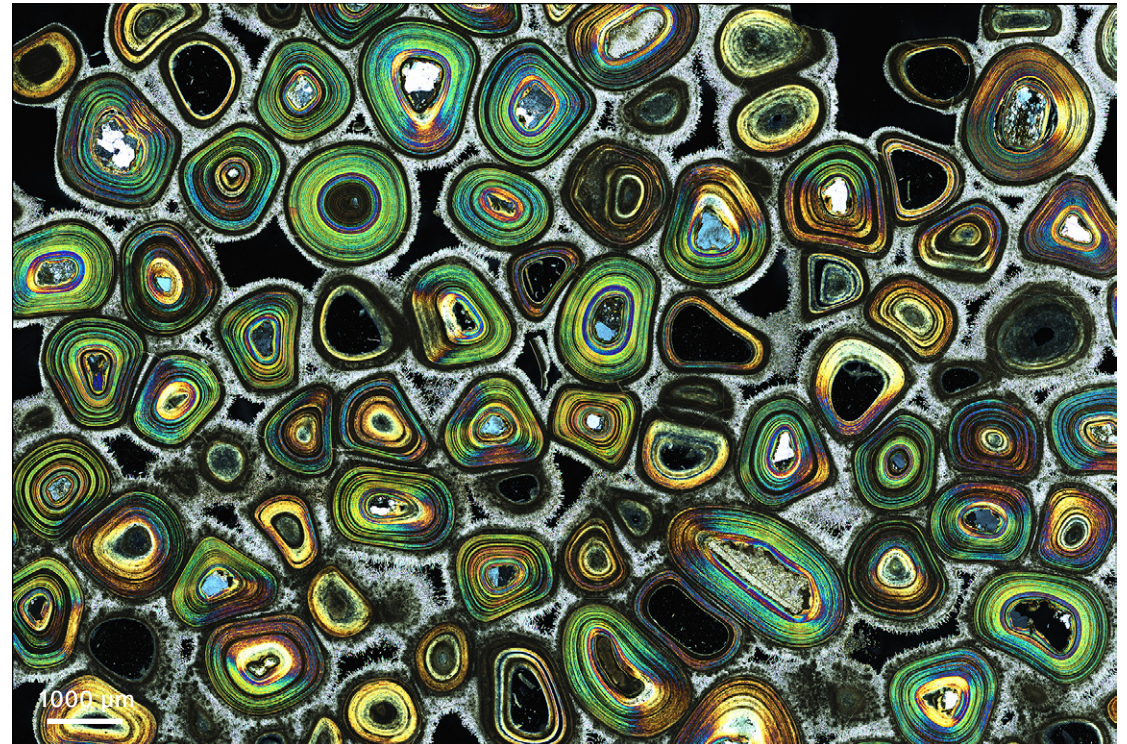

*Thin section of Karlsbader Sprudelstein, scanned with 10x N-Achroplan 0.45 Pol. A merged image of the cross linear polarized light channels is shown. Sample courtesy of Bernardo Cesare, Università di Padova, Italy*

Subsequent higher magnification acquisitions using other imaging systems in the facility, like confocal systems, are easily guided using ZEN Connect and as such, previously time-consuming studies are reduced in both time and complexity.

Support your users with easy to learn automated scanning that offers great flexibility while requiring minimal training.



# Expand Your Possibilities

- › In Brief
- › **The Advantages**
- › The Applications
- › The System
- › Technology and Details
- › Service

## ZEISS Predictive Service

### Maximizes System Uptime

Once connected to your network and activated, this advanced technology will automatically track the health status of your instrument and collect system log files in the background to improve remote diagnosis.

Relevant technical data such as operating hours, cycle counts or voltages are periodically monitored via a secure connection to our data center. The ZEISS Predictive Service application evaluates the performance of your microscope as system data can be received and analyzed.

Our support engineers will diagnose any issues by analyzing data on the Enterprise Server – remotely and without interruption to your operation.

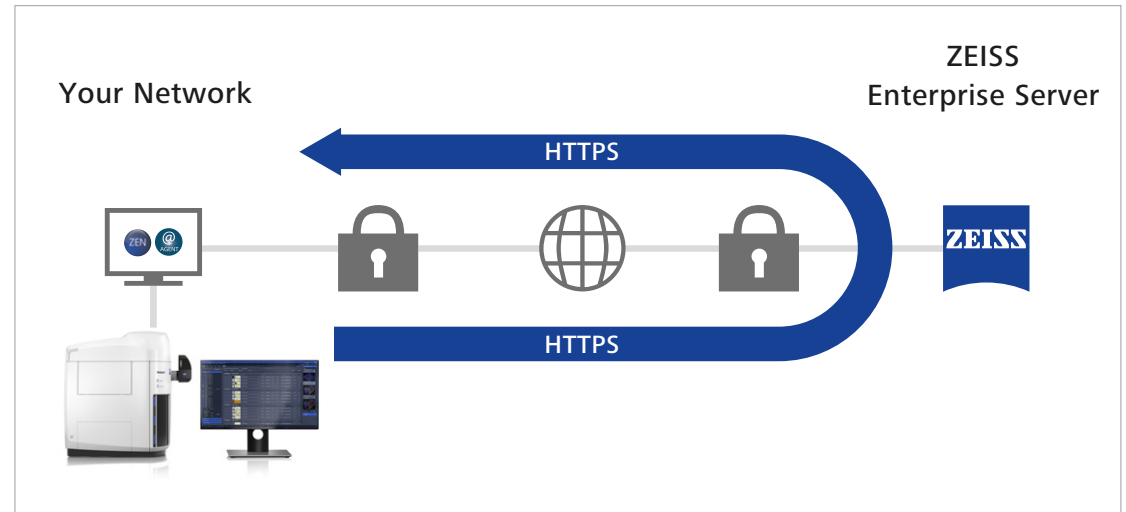

#### ■ **Maintain highest system availability**

Increase your uptime through close monitoring of the system's condition as remote support can often provide immediate solutions.

#### ■ **Data security**

Ensure highest data security standards using well established technologies like PTC Thingworx and Microsoft Azure Cloud. No personal or image data is uploaded, only machine data.

#### ■ **Fast and competent support**

Use secure remote desktop sharing to easily get an expert connected.

#### ■ **Optimum instrument performance**

As the status of your system is monitored, necessary actions can be planned before they become urgent.

# Tailored Precisely to Your Applications

- › In Brief
- › The Advantages
- › **The Applications**
- › The System
- › Technology and Details
- › Service

Typical Applications / Typical Samples	Task	ZEISS Axioscan 7 Offers
High throughput digitization or extended sections of rock core	Optimized acquisition of potentially thousands of core rock samples, maximizing both image information and sample throughput.	High throughput plane and circular polarization, allowing for diagnostic maximum birefringence information to be digitized at unprecedented speed.
Digitization of complete petrographic information for historic or research collections	Thousands of historical thin sections must be digitized and archived with minimal user interaction or operator burden.	Automated scanning of up to 100 slides (25 × 75 mm) with minimal user overhead for sample setup, automated naming and sample detection.
Visualization of complex multichannel datasets through an intuitive interactive virtual petrographic microscope	Visualize complex petrographic data comprised of brightfield, plane polarized, cross linear polarized and circular polarized and fluorescence information in a intuitive and easy to navigate way, creating the experience of working with a petrographic microscope.	ZEN Pol Viewer allows for the easy, intuitive switching between contrast modes, even allowing for the virtual synchronized rotation of a virtual "petrographic stage", allowing for simultaneous visualization of birefringence and pleochroism.
Microfossil imaging	High resolution scanning in all available light modes	A wide array of high ZEISS-quality objectives up to a magnification of 50X and a numerical aperture of 0.95 for the crispest, highest resolution polarization images.
Palynology	High resolution, high throughput digitization of large area pollen slides with samples displaying significant topography.	Rapid extended depth of field (EDF) scanning using the same speedy acquisition technology available for brightfield and polarization microscope.
Quantitative analysis of pore and mineral phases	Translation of image data to quantified analysis of petrologically or petrophysically relevant parameters (e.g. pore size distribution)	Quantify mineral and pore phases in digitized data using advanced AI based segmentation with ZEN Intellesis and ZEN Image Analysis.
Grain and texture analysis	Quantitatively describe extinction angles and grain orientations from digitized multi-polarized petrographic datasets.	Use highly optimized birefringence solver within the Petrography Analysis Toolbox to find individual crystal boundaries, identifying individual connected mineral grains, even if they are not morphologically distinct.
Identification of region for correlative analysis (e.g. through pleochroic halos)	Target regions from large scale overview petrographic scan for quantitative microanalysis (e.g. quantitative mineralogy using ZEISS Mineralogic)	Rich, large area data to provide the large area map for targeted microanalysis.
Identification of fluid inclusions	Rapid large area scanning of sample, coupled with transmitted light illumination to identify the distribution of fluid inclusions.	The Axioscan 7 provides the most flexible system for characterization, enabling brightfield, polarization and illumination.
Online or blended teaching Global collaboration	Global distribution of acquired petrographic datasets using a browser based viewer.	Web-centric data visualization and management using ZEN Data Storage and Explorer.



# ZEISS Axioscan 7 at Work

- › In Brief
- › The Advantages
- › **The Applications**
- › The System
- › Technology and Details
- › Service

## Flexible acquisition of complex petrographic data

Brightfield

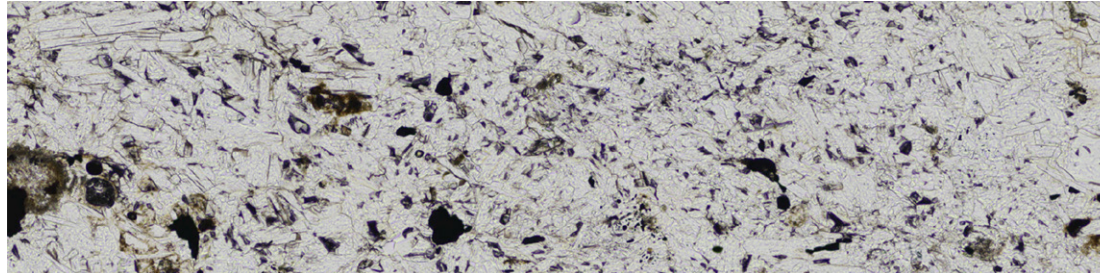

Crossed polarized

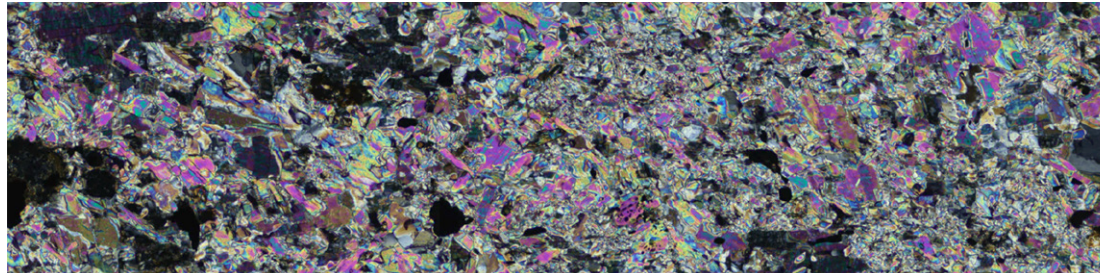

Circular polarized

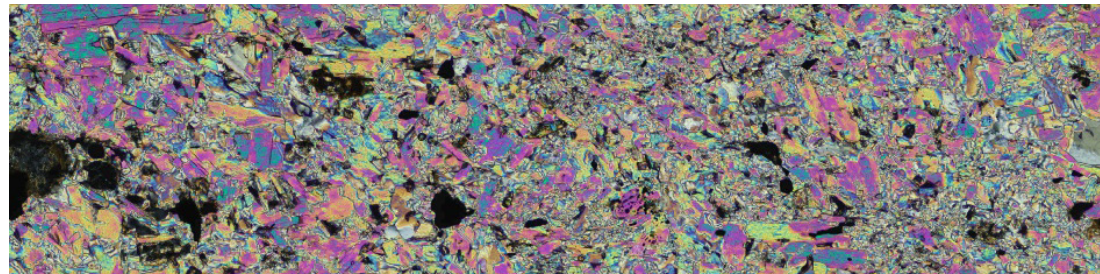

Multichannel acquisition of geological sample. Different forms of polarization illumination can be used to highlight different features. Brightfield scanning shows overall crystal color, habit and relationship to other features. Crossed polarized illumination at multiple orientations allows for extinction angles to be assessed. Circular polarization shows the maximum birefringence of all elements in the sample with just one shot. All channels are stitched and aligned using powerful computational algorithms during acquisition, producing data ready for subsequent segmentation and analysis.

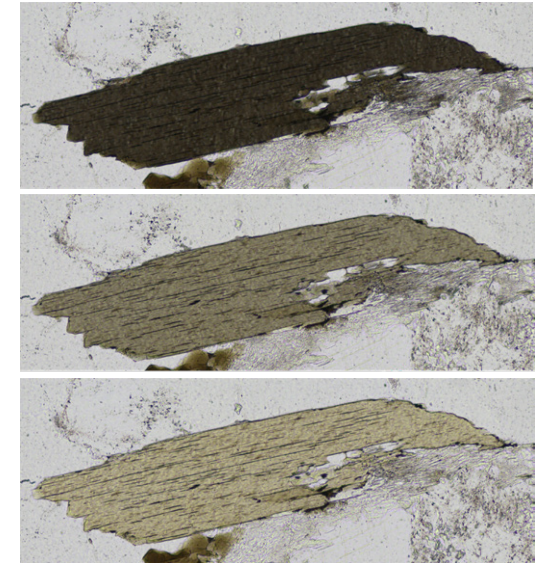

ZEISS Axioscan 7 now features a motorized polarizer allowing illumination with many angles of direct polarized light, also known as plane polarized light (PPL). This allows for the observation of pleochroism such as that seen in this biotite crystal in granite.



# ZEISS Axioscan 7 at Work

- › In Brief
- › The Advantages
- › **The Applications**
- › The System
- › Technology and Details
- › Service

## Pore, mineral and grain size distribution using quantitative image analysis

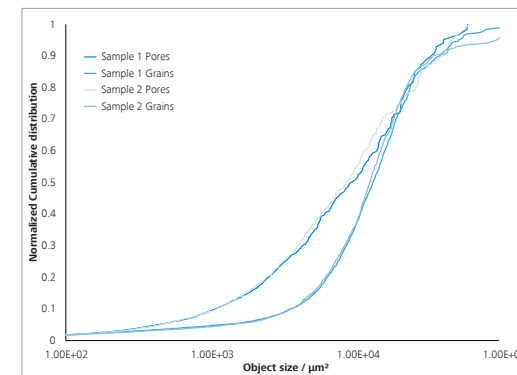
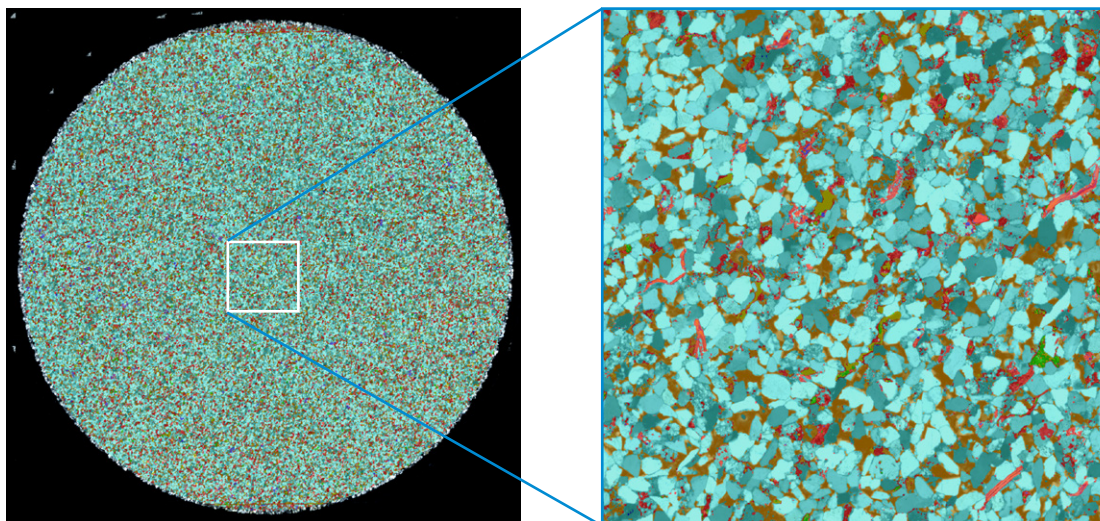
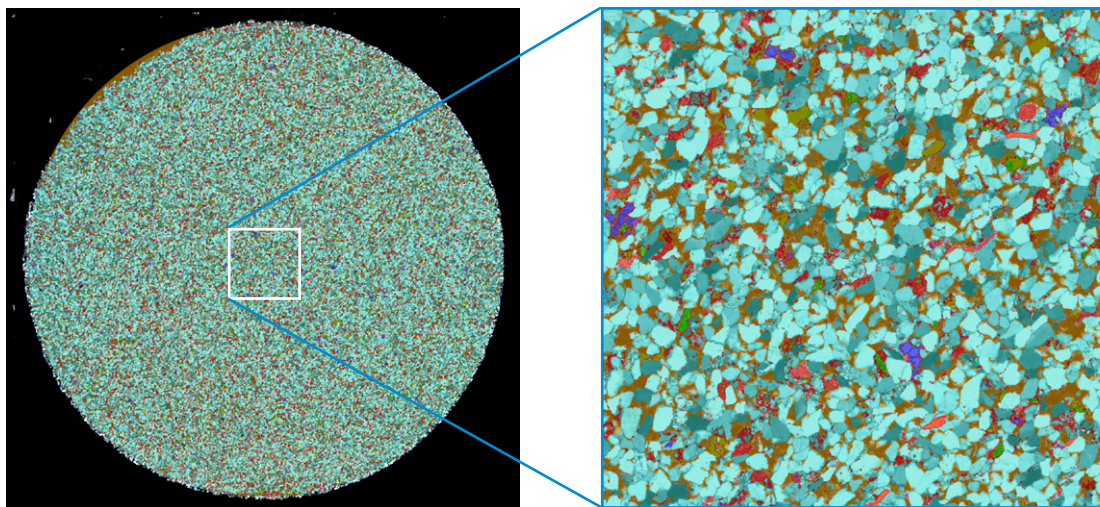

Phase	Sample 1	Sample 2
Pore	19.81	18.38
Quartz	69.96	72.36
Micas	8.43	7.59
Calcite	0.33	0.34
High relief minerals	0.57	0.5
Opagues	0.89	0.83

Automated machine-learning based mineral classification using a single ZEN Intellesis model, applied on two samples of Berea sandstone, a standard test quarry sample for flow and transport in porous media. Both modal mineralogy and pore / grain sizes can be measured and automatically reported. In these samples, a slight decrease in the sample porosity between sample 1 and 2 is caused by a slight increase in the Quartz contribution.



# ZEISS Axioscan 7 at Work

- › In Brief
- › The Advantages
- › **The Applications**
- › The System
- › Technology and Details
- › Service

**Correlate your workflows with ease through light, electron, and X-ray microscopy**

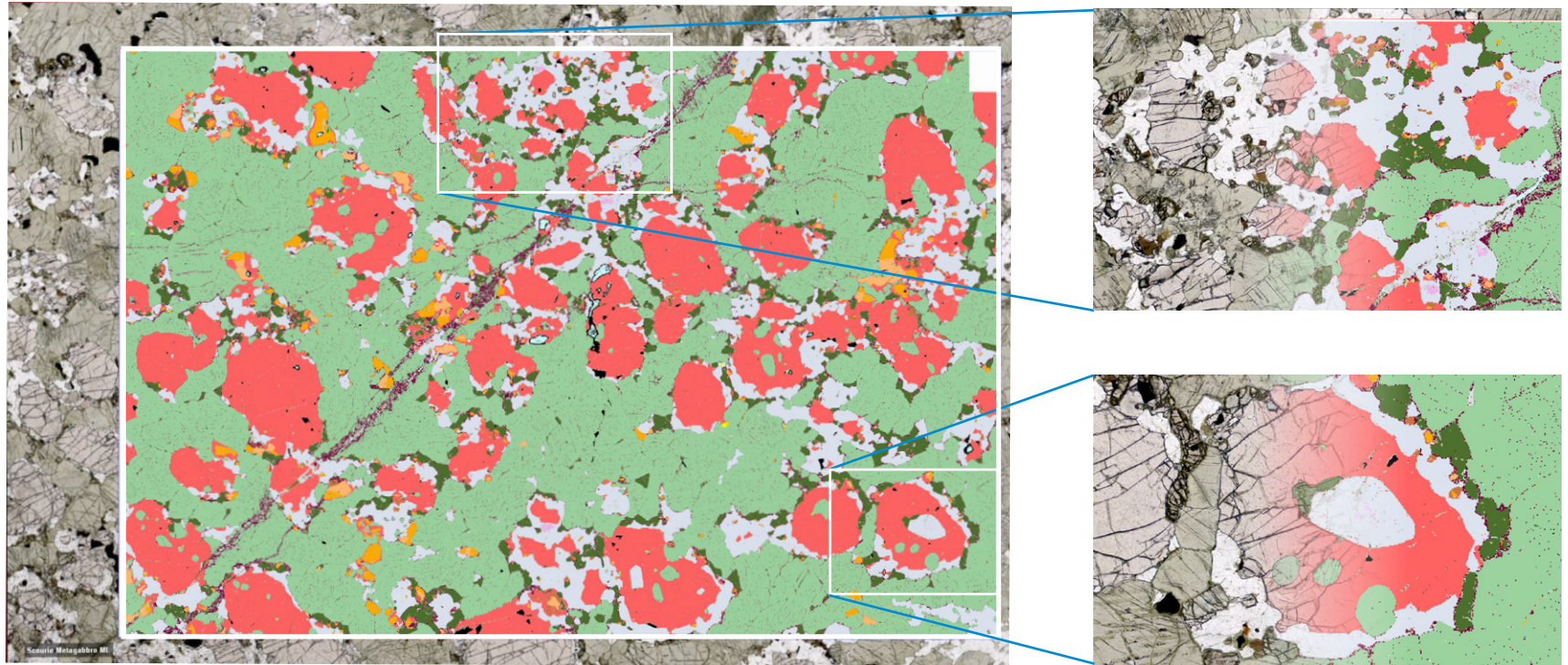

*Bringing the petrographic observations of light microscopy into the digital age allows for effective project building, and the streamlining of petrology workflows. Batch processing of thin section collections across entire field area allows quantitative data to be rapidly assessed, highlighting focus points of your study. These key areas can be further interrogated with multiple additional techniques such as quantitative chemistry from full thin sections using ZEISS Mineralogic (scanning electron microscope based automated mineral analysis solution). Effective digitisation of every aspect of your project is a critical step in modern collaborative efforts that may involve multiple institutions around the globe.*

# Your Flexible Choice of Components

- › In Brief
- › The Advantages
- › The Applications
- › **The System**
- › Technology and Details
- › Service



## 1 Microscope

- Axioscan 7
- Magazines for 12 or 100 slides
- Trays for four 26 mm × 77 mm slides, two 52 mm × 77 mm slides or 28 mm × 48 mm and 106 mm × 77 mm slides

## 2 Objectives

- Fluor (5×)
- N-Achroplan Pol (5×, 10×, 20×)
- Plan-Apochromat (10×, 20×, 40×)
- EC Plan-Neofluar Pol (20×, 40×)
- EC Epiplan-Neofluar Pol (5×, 10×, 20×, 50×)
- Other objectives on request

## 3 Illumination

- Transmitted light: LED (wavelength 400 to 700 nm)
- Fluorescence: LED: 385 nm, 423 nm, 469 nm, 511 nm, 555 nm, 590 nm, 631 nm, 735 nm

Filter wheels:

- 10-position ACR for filter cubes or
- 6-position high-speed excitation
- 6-position high-speed beamsplitter and 6-position high-speed emission

## 4 Cameras

- AxioCam 705 color
- AxioCam 712 mono
- Hamamatsu ORCA-Flash 4.0

## 5 Software

- ZEN slidescan
- ZEN lite
- ZEN Intellesis
- ZEN Image Analysis
- ZEN Data Storage & Data Explorer
- ZEISS Solutions Lab

# System Overview

- › In Brief
- › The Advantages
- › The Applications
- › **The System**
- › Technology and Details
- › Service

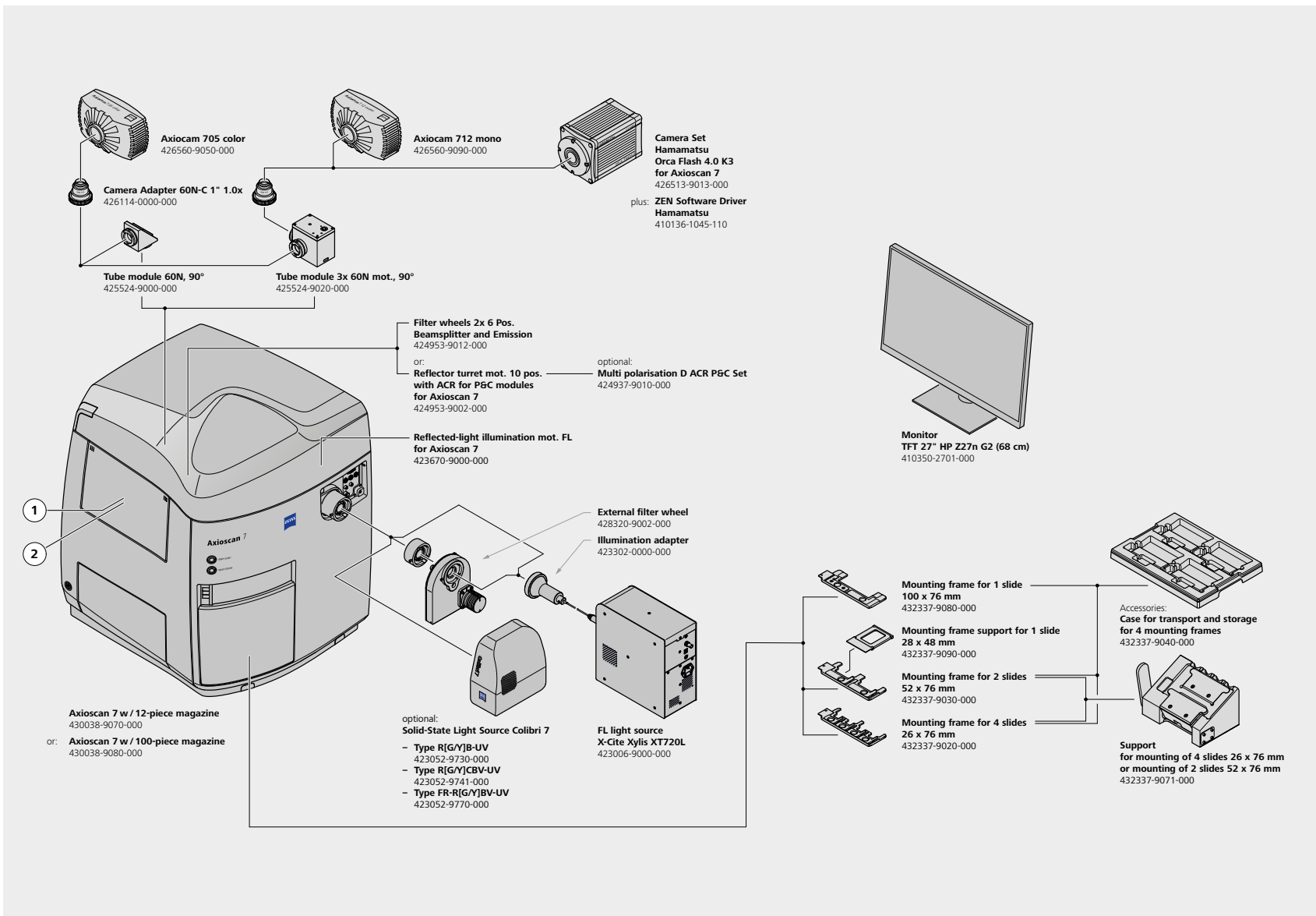



# System Overview

- › In Brief
- › The Advantages
- › The Applications
- › **The System**
- › Technology and Details
- › Service

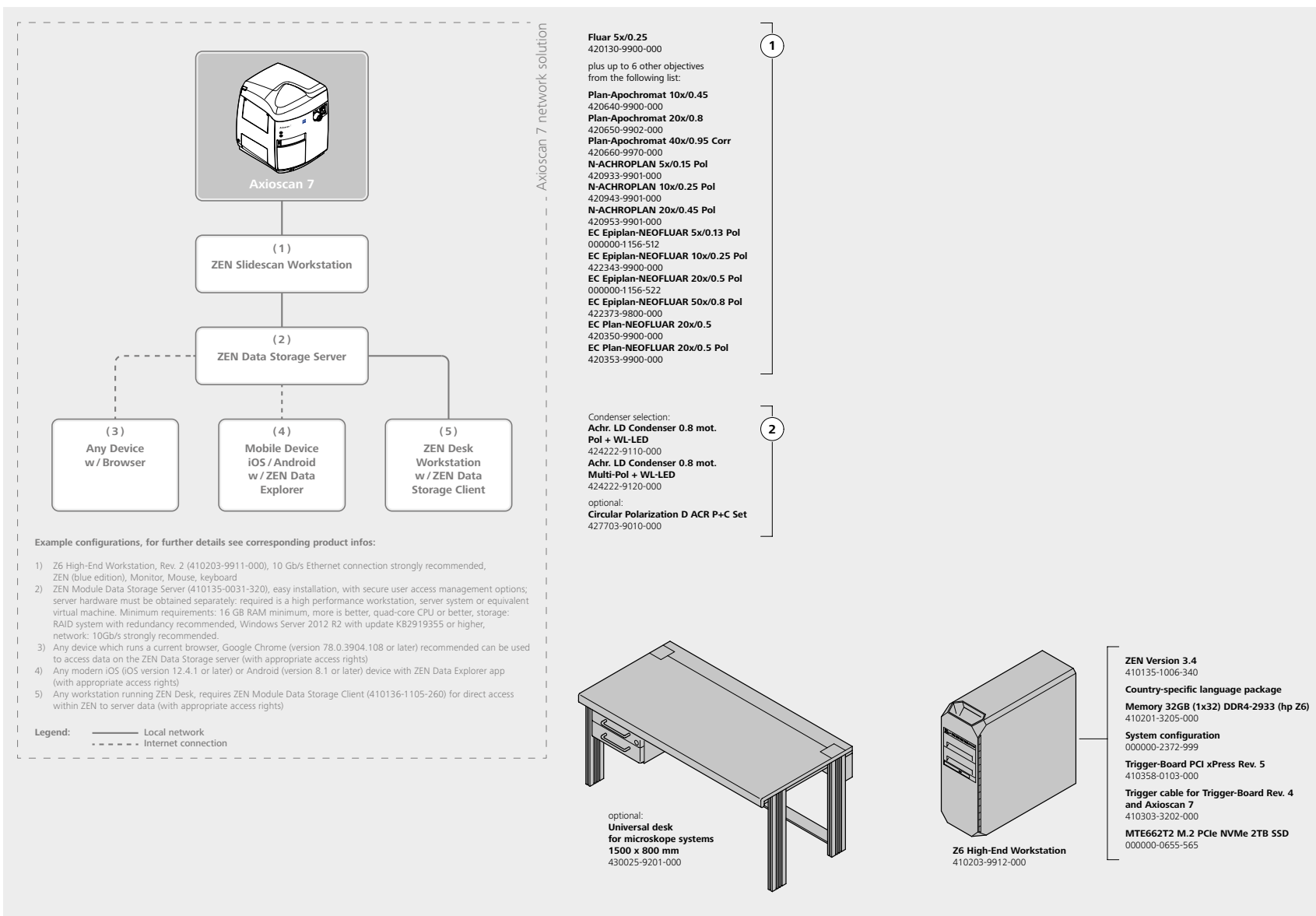

# Technical Specifications

- › In Brief
- › The Advantages
- › The Applications
- › The System
- › **Technology and Details**
- › Service

## Dimensions (width × depth × height)

Axioscan 7 (brightfield)	Approx. 695 mm × 579 mm × 813 mm
Axioscan 7 (brightfield and fluorescence with Colibri 7)	Approx. 912 mm × 579 mm × 813 mm

## Mass

Axioscan 7 (brightfield, 12 slides)	Approx. 100 kg
Axioscan 7 (brightfield and fluorescence with Colibri 7 and 100 slides)	Approx. 115 kg

## Environmental conditions for transport (in packaging)

Permissible ambient temperature	-35 °C to +60 °C
---------------------------------	------------------

## Storage

Permissible ambient temperature	-10 °C to +55 °C
Permissible relative humidity (without condensation)	Max. 90 % at 55 °C

## Operation

Permissible ambient temperature	+10 °C to +30 °C (with X-Cite Xylis: +15 °C to +30 °C)
Permissible relative humidity	Max. 75 % at 30 °C
Highest permitted altitude of use	Max. 2000 m
Atmospheric pressure	800 hPa to 1060 hPa
Degree of pollution	2

## Operating data

Operational area	Closed rooms
Protection class	I
Electrical safety	Conforming to DIN EN 61010-1 (IEC 61010-1), DIN EN 61010-2-101 (IEC 61010-1 and IEC 61010-2-101) in CSA and UL regulations
Overvoltage category	II
RFI suppression	Conforming to EN 55011 class A
Noise immunity	Conforming to DIN EN 61326-1 and DIN EN 61326-2-6
Input voltage, basic unit (Mains voltage does not need to be converted!)	100 V AC to 240 V AC
Power frequency	50 / 60 Hz
Power consumption	Max. 260 VA
Fuses	2× T 5.0A / H 250V, 5 × 20 mm; 1× T 5.0A 250V 6 × 32 mm

# Technical Specifications

- › In Brief
- › The Advantages
- › The Applications
- › The System
- › **Technology and Details**
- › Service

## Pixel resolution (Axiocam 712 mono / Axiocam 705 color)

10x	0.345 $\mu\text{m}$ /pixel
20x	0.173 $\mu\text{m}$ /pixel
40x	0.086 $\mu\text{m}$ /pixel

## Reflector turret

Reflector turret with ACR for push and click filter sets

Number of positions	10
Type	Optically encoded (no detents)
Switching time	Approx. 400 ms (between neighboring positions)

## High-speed filter wheels for single filter or beamsplitter

Number of positions	6
Type	Optically encoded (no detents) Separate control of excitation, beamsplitter and emission filter wheel
Switching time	Approx. 50 ms (between neighboring positions)

## Motorized condenser modulator disk

Number of positions	4
---------------------	---

## Contrasting techniques

Transmitted light brightfield
Transfer of Intensity Equation (TIE)
Transmitted light polarization (linear, crossed linear, circular)
Reflected light fluorescence
Reflected light brightfield



# Technical Specifications

- › In Brief
- › The Advantages
- › The Applications
- › The System
- › **Technology and Details**
- › Service

Light sources		
Transmitted light	WL-LED (wavelength: 400 to 700 nm)	
Fluorescence	Colibri 7 (wavelength: 385 nm, 423 nm, 469 nm, 511 nm, 555 nm, 590 nm, 631 nm, 735 nm); X-Cite Xylis LT720L (wavelength: 380 nm to 770 nm)	
Thumbnail generation		
Labeling area	Separate camera with reflected light illumination	
Specimen area (brightfield)	Separate camera with transmitted light illumination	
Specimen area (fluorescence)	5× objective with transmitted light illumination (TIE) or reflected light illumination (fluorescence)	
Z stack		
Imaging of Z stacks and application of extended depth of field function		
Bar codes and optical character recognition		
1D barcode types		
Australian Post	Industrial 2of5	RSS 14 Truncated
Code 11	MSI	RSS 14 Limited
Code 39 (Code 3of9)	PatchCode	RSS 14 Expanded
Code 93	Planet	RSS 14 Stacked
Code 128 (UCC/EAN128)	Postnet	RSS 14 Stacked Omni
Codabar	Plus2 (EAN-EXT-2)	RSS 14 Expanded Stacked
Code Interleaved 2of5	Plus5 (EAN-EXT-5)	UPC-A
EAN-8	Royal Mail	UPC-E
EAN-13	RSS 14	USPS OneCode
2D barcode types		
Aztec	MicroPDF417	
Datamatrix	Micro QR Code	
■ Numeric encoding	PDF417 (Standard encoding type)	
■ Alpha encoding	QR Code (QR code Model 1, 2 encoding)	
■ AlphaNumericPunc encoding		
■ AlphaNumeric encoding		
■ ASCII encoding		
■ IS08 encoding		
Maxi		
Optical Character Recognition (OCR)		
The following fonts are supported: American Typewriter, Arial, Bodoni, Bookman, Calibri, Courier, DIN 1451, Eurostyle, FF DIN, Fixed, Fixedsys, Frutiger, Letter Gothic, MS Sans Serif, OCR A, OCR B, Prestige, Segoe UI, Times New Roman, Verdana		
Compression		
Lossless or lossy with JPEGXR (quality can be adjusted)		
Optional software components		
Image analysis	ZEN (blue edition) image analysis modules	
Database and remote viewing	ZEN Data Storage, ZEN Data Explorer	
Image viewing	ZEN lite (freeware)	

# Technical Specifications

- › In Brief
- › The Advantages
- › The Applications
- › The System
- › **Technology and Details**
- › Service

<b>Magazine</b>			
Capacity	12 slides (26 mm × 77 mm)	100 slides (26 mm × 77 mm)	
Tray	for 4 slides (26 mm × 77 mm)	for 2 slides (52 mm × 77 mm or 28 mm × 48 mm)	for 1 slide (106 mm × 77 mm)
Usable slides	Length	Width	Thickness
26 mm × 77 mm (DIN ISO 8037/1 and A-A 50831)	73.5 mm ... 76.5 mm	24.0 mm ... 26.0 mm	0.8 mm ... 1.3 mm
52 mm × 77 mm (DIN ISO 8037/1)	73.5 mm ... 76.5 mm	50.0 mm ... 52.0 mm	0.8 mm ... 1.3 mm
106 mm × 77 mm	73.5 mm ... 76.5 mm	99.0 mm ... 106.0 mm	0.8 mm ... 1.3 mm
28 mm × 48 mm	26.0 mm ... 28.2 mm	46.0 mm ... 48.2 mm	1.0 mm ... 1.6 mm
Other dimensions on request			
<b>Objectives</b>			
Number of usable objectives	Up to 7 with automatic switching		
<b>List of usable objectives (other objectives on request)</b>			
Fluar (5×)	EC Plan-Neofluar Pol (20×, 40×)		
N-Achroplan Pol (5×, 10×, 20×)	EC Epiplan-Neofluar Pol (5×, 10×, 20×, 50×)		
Plan-Apochromat (10×, 20×, 40×)			
<b>Cameras</b>			
Number of cameras	Up to 2 with automatic switching		
<b>List of usable cameras</b>			
Axiocam 705 color (brightfield)			
Axiocam 712 mono (fluorescence)			
Hamamatsu ORCA-Flash 4.0 (fluorescence)			



# Count on Service in the True Sense of the Word

- › In Brief
- › The Advantages
- › The Applications
- › The System
- › Technology and Details
- › **Service**

Because the ZEISS microscope system is one of your most important tools, we make sure it is always ready to perform. What's more, we'll see to it that you are employing all the options that get the best from your microscope. You can choose from a range of service products, each delivered by highly qualified ZEISS specialists who will support you long beyond the purchase of your system. Our aim is to enable you to experience those special moments that inspire your work.

## **Repair. Maintain. Optimize.**

Attain maximum uptime with your microscope. A ZEISS Protect Service Agreement lets you budget for operating costs, all the while reducing costly downtime and achieving the best results through the improved performance of your system. Choose from service agreements designed to give you a range of options and control levels. We'll work with you to select the service program that addresses your system needs and usage requirements, in line with your organization's standard practices.

Our service on-demand also brings you distinct advantages. ZEISS service staff will analyze issues at hand and resolve them – whether using remote maintenance software or working on site.

## **Enhance Your Microscope System.**

Your ZEISS microscope system is designed for a variety of updates: open interfaces allow you to maintain a high technological level at all times. As a result you'll work more efficiently now, while extending the productive lifetime of your microscope as new update possibilities come on stream.

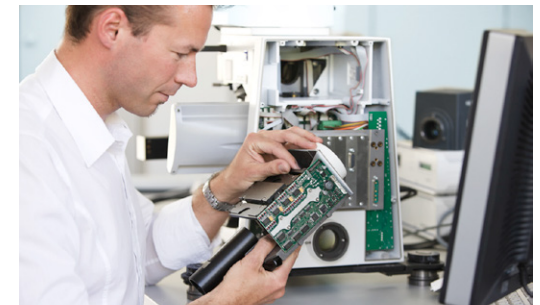

*Profit from the optimized performance of your microscope system with services from ZEISS – now and for years to come.*

>> [www.zeiss.com/microservice](http://www.zeiss.com/microservice)





**Carl Zeiss Microscopy GmbH**  
07745 Jena, Germany  
microscopy@zeiss.com  
www.zeiss.com/axioscan-geo